

Standardschnitt Glasstärke bzw. Wangentiefe können abweichen

 <p>fenlife Fenster fürs Leben.</p>	Fenlife PUR 68	FORMAT: A4 Gez: SP
	Detail oben	Mst: 1:1 Z.Nr.:
<p>Fritschi Fensterbau AG Grundstrasse 39 8196 Wil/ZH</p>		<p>Tel. 043 433 33 66 Fax 043 433 33 67 info@fritschi-fensterbau.ch www.fritschi-fensterbau.ch</p>
		<p>Gez: 01.01.2014 Rev: Druck:19.08.2017</p>

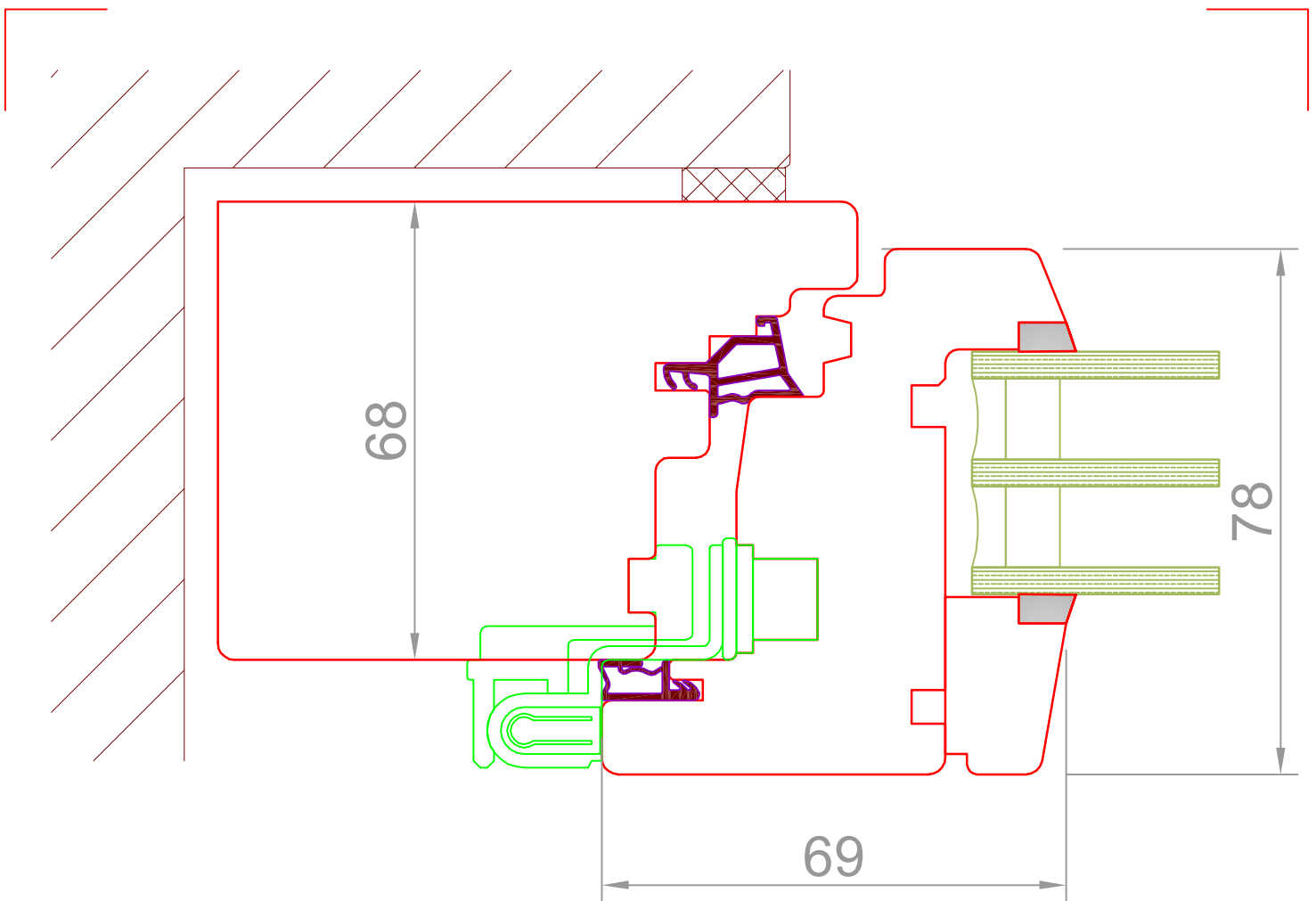

Flügelvariante mit
winkligem Glasstab

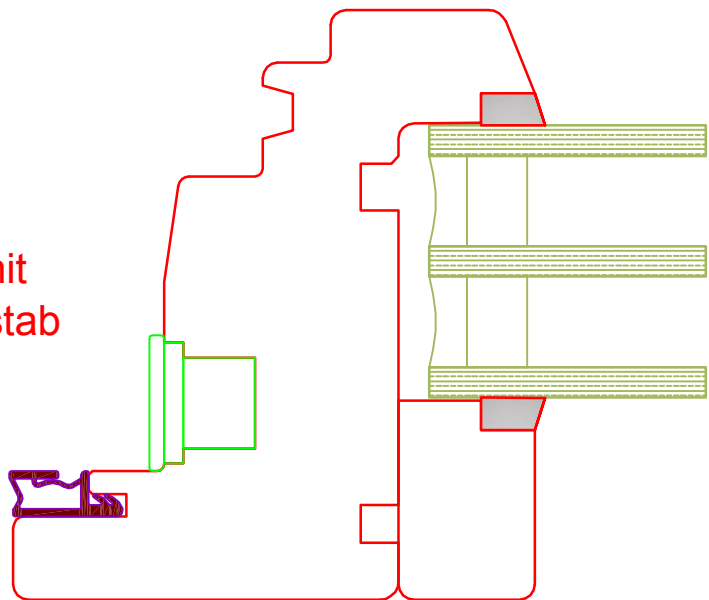

Standardschnitt Glasstärke bzw. Wangentiefe können abweichen

 Fenster fürs Leben.	Fenlife PUR 68	FORMAT: A4 Gez: SP
	Detail seitlich	Mst: 1:1 Z.Nr.:
Fritschi Fensterbau AG Grundstrasse 39 8196 Wil/ZH		Tel. 043 433 33 66 Fax 043 433 33 67 info@fritschi-fensterbau.ch www.fritschi-fensterbau.ch
		Gez: 01.01.2014 Rev: Druck:19.08.2017

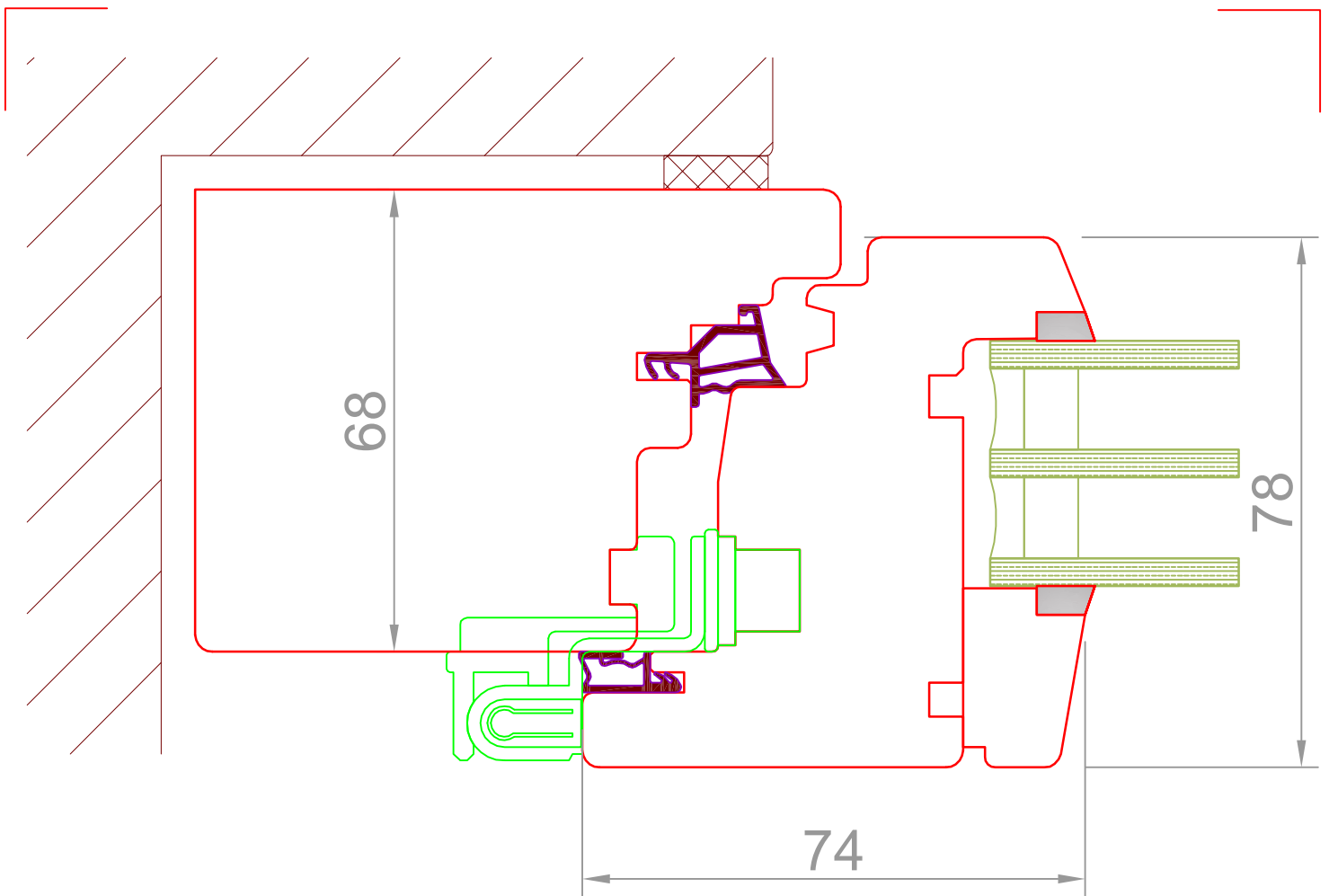

Flügelvariante mit
winkligem Glasstab

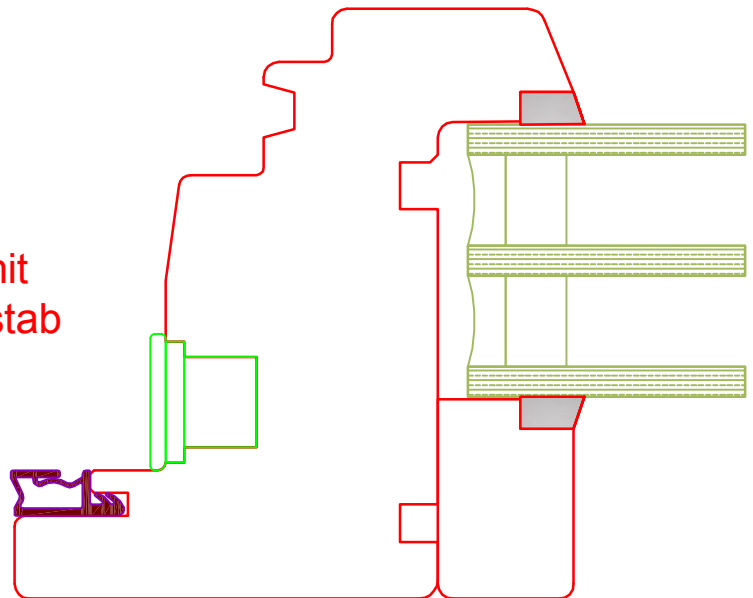

Standardschnitt Glasstärke bzw. Wangentiefe können abweichen

 fenlife Fenster fürs Leben.	Fenlife PUR 68	FORMAT: A4 Gez: SP
	Detail seitlich	Mst: 1:1 Z.Nr.:
Fritschi Fensterbau AG Grundstrasse 39 8196 Wil/ZH		Tel. 043 433 33 66 Fax 043 433 33 67 info@fritschi-fensterbau.ch www.fritschi-fensterbau.ch
		Gez: 01.01.2014 Rev: Druck: 23.09.2017

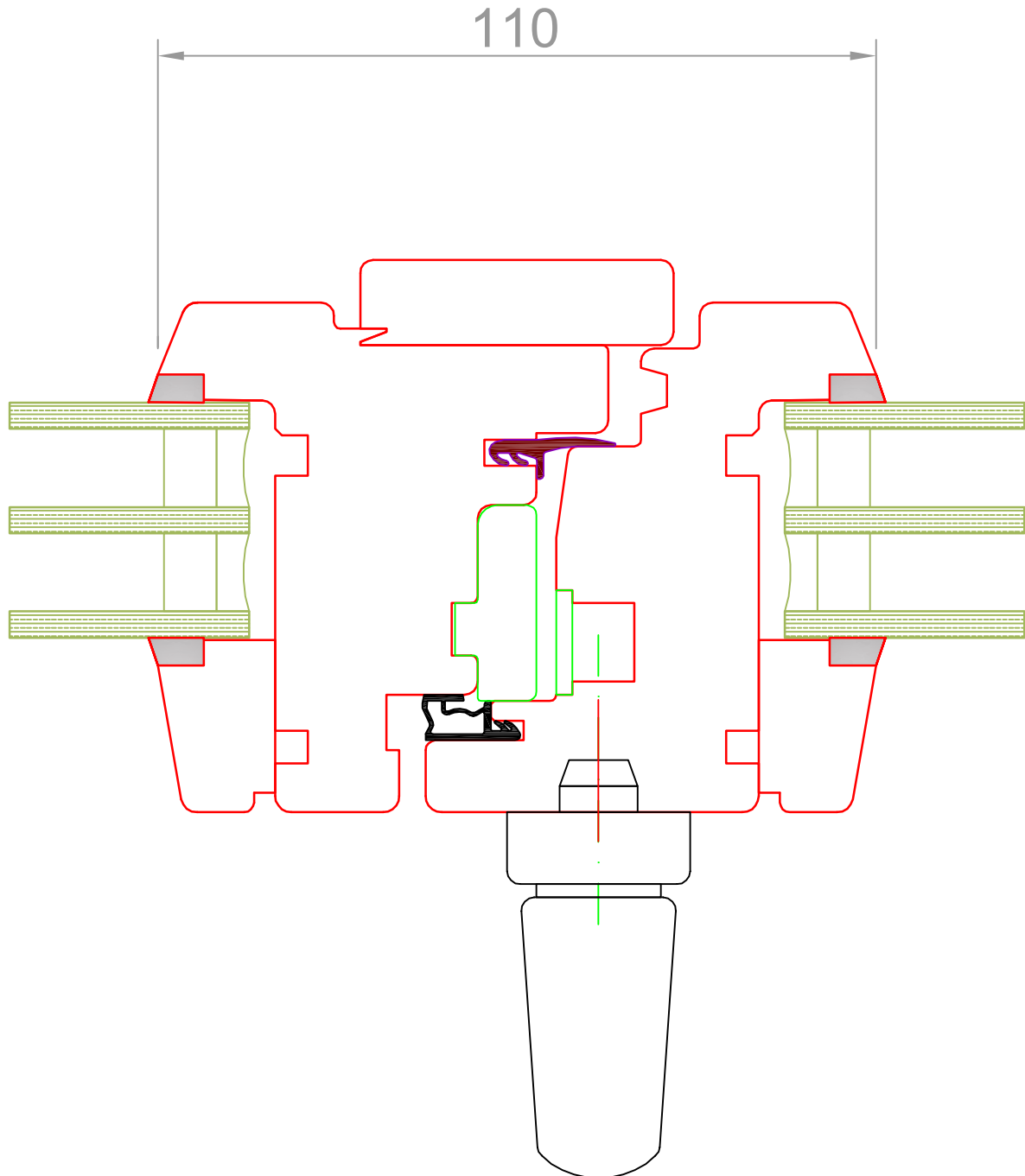

Standardschnitt Glasstärke bzw. Wangentiefe können abweichen

 Fenster fürs Leben.	Fenlife PUR 68	FORMAT: A4 Gez: SP
	Detail Mittelpartie 6.5 mm Getriebe	Mst: 1:1 Z.Nr.:
Fritschi Fensterbau AG Grundstrasse 39 8196 Wil/ZH		Tel. 043 433 33 66 Fax 043 433 33 67 info@fritschi-fensterbau.ch www.fritschi-fensterbau.ch
		Gez: 01.01.2014 Rev: Druck: 23.09.2017

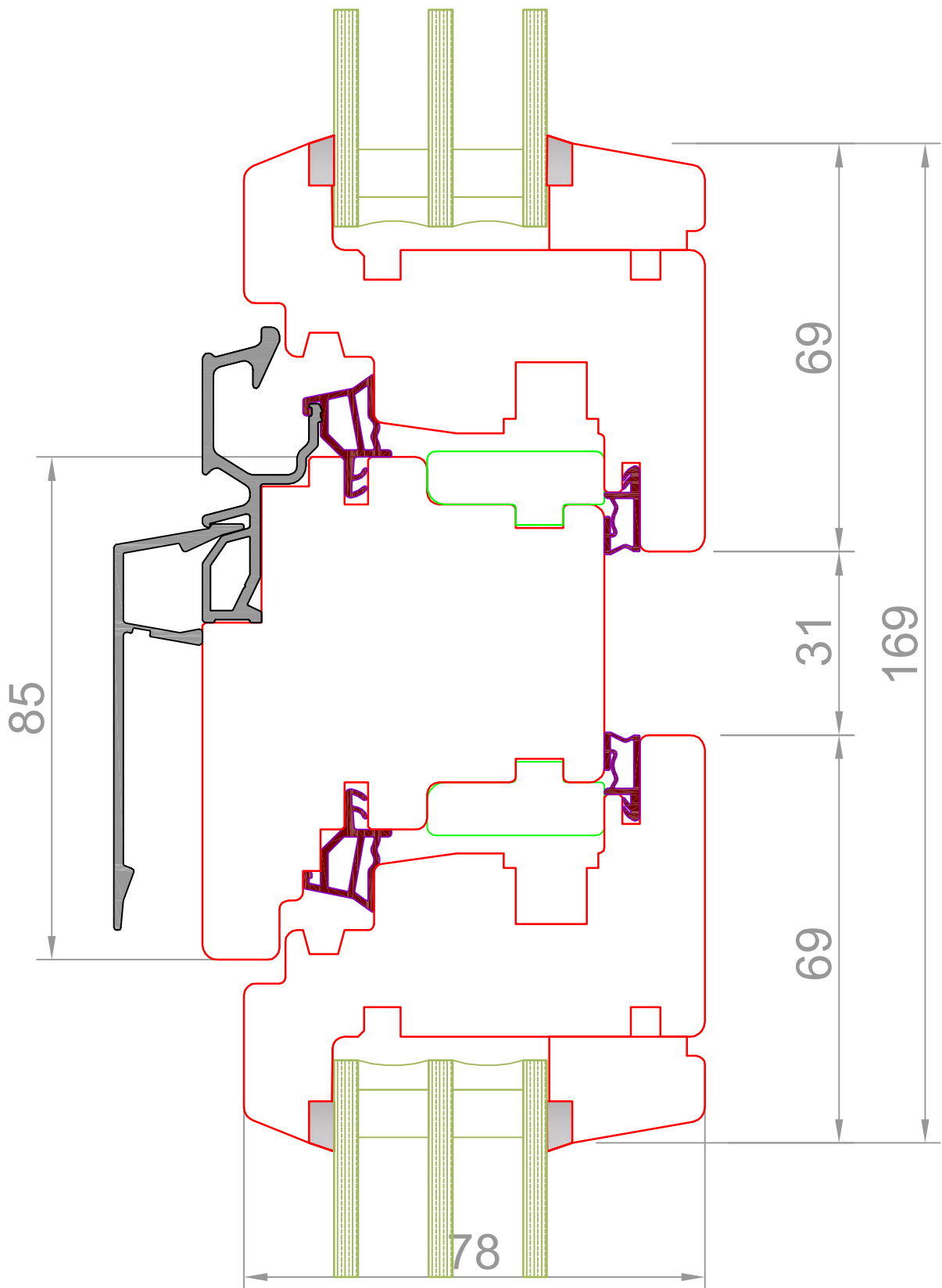

Standardschnitt Glasstärke bzw. Wangentiefe können abweichen

 fenlife Fenster fürs Leben.	Fenlife PUR 68	FORMAT: A4 Gez: SP
	Detail Kämpfer	Mst: 1:1 Z.Nr.:
Fritschi Fensterbau AG Grundstrasse 39 8196 Wil/ZH		Tel. 043 433 33 66 Fax 043 433 33 67 info@fritschi-fensterbau.ch www.fritschi-fensterbau.ch
		Gez: 01.01.2014 Rev: Druck:19.08.2017

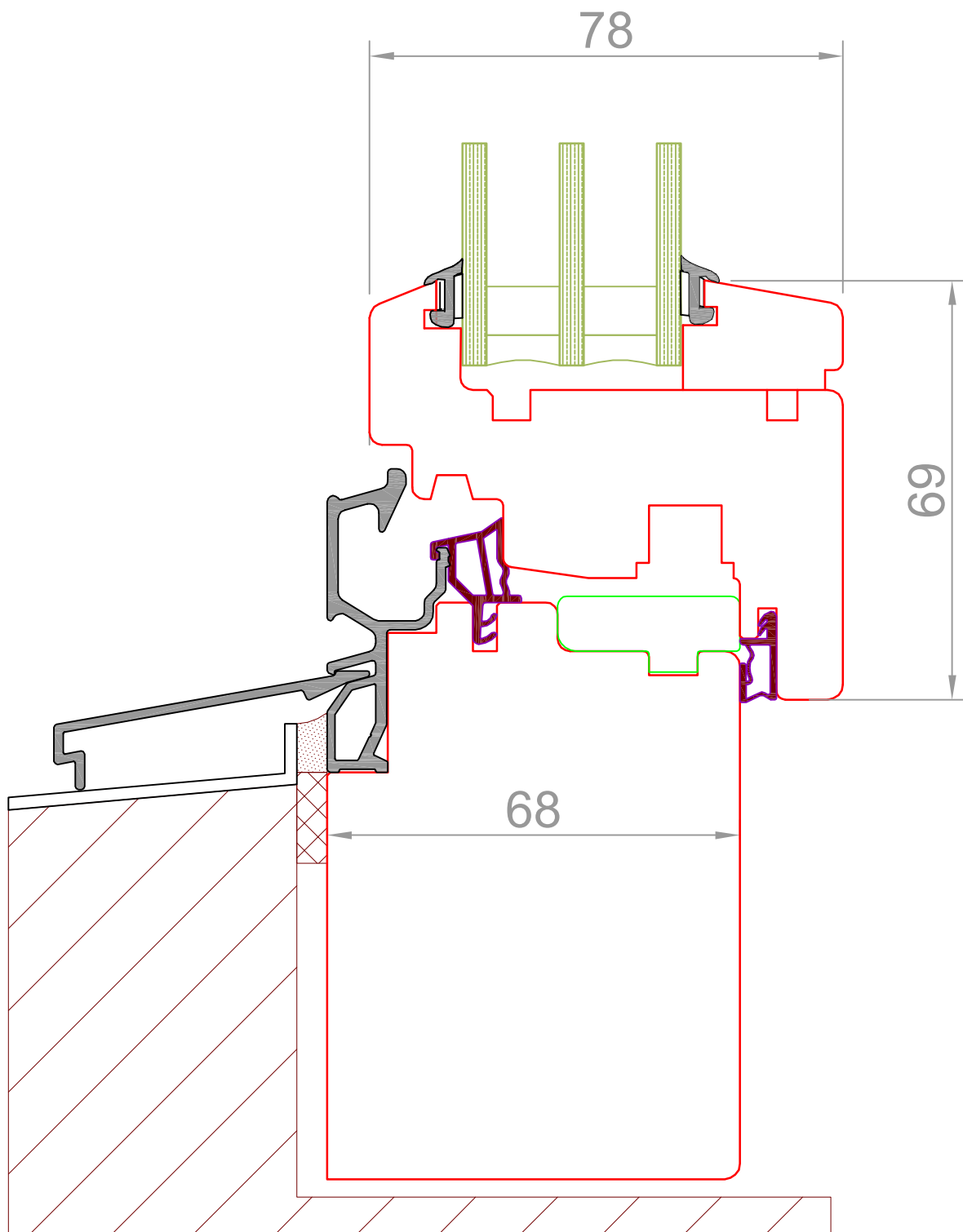

Standardschnitt Glasstärke bzw. Wangentiefe können abweichen

 fenlife Fenster fürs Leben.	Fenlife PUR 68	FORMAT: A4 Gez: SP
	Detail unten	Mst: 1:1 Z.Nr.:
Fritschi Fensterbau AG Grundstrasse 39 8196 Wil/ZH		Tel. 043 433 33 66 Fax 043 433 33 67 info@fritschi-fensterbau.ch www.fritschi-fensterbau.ch
		Gez: 01.01.2014 Rev: Druck: 19.08.2017

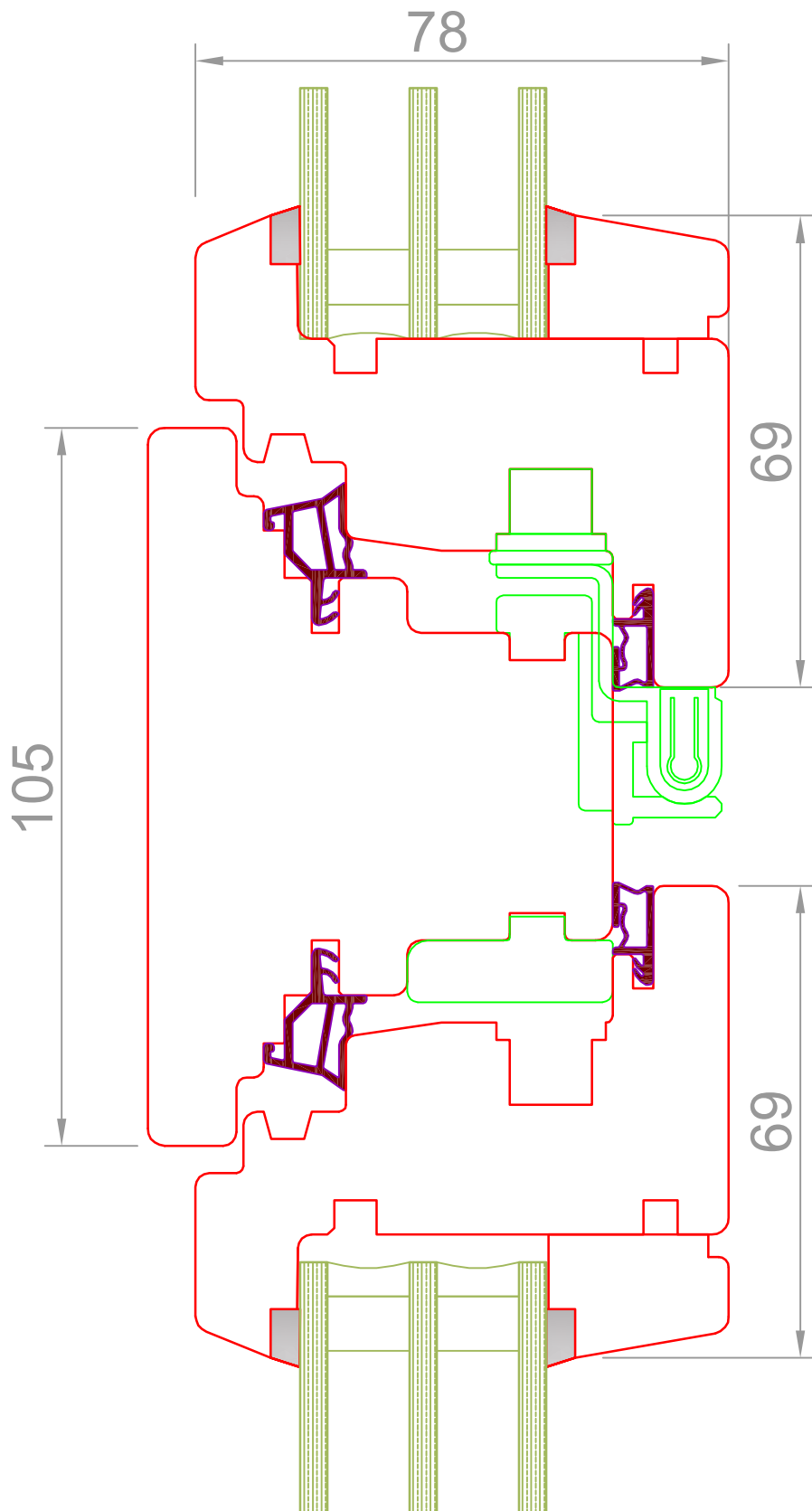

Standardschnitt Glasstärke bzw. Wangentiefe können abweichen

 <p>fenlife Fenster fürs Leben.</p>	Fenlife PUR 68	FORMAT: A4 Gez: SP
	Detail Setzholz 105	Mst: 1:1 Z.Nr.:
<p>Fritschi Fensterbau AG Grundstrasse 39 8196 Wil/ZH</p> 	<p>Tel. 043 433 33 66 Fax 043 433 33 67 info@fritschi-fensterbau.ch www.fritschi-fensterbau.ch</p>	<p>Gez: 01.01.2014 Rev: Druck: 19.08.2017</p>

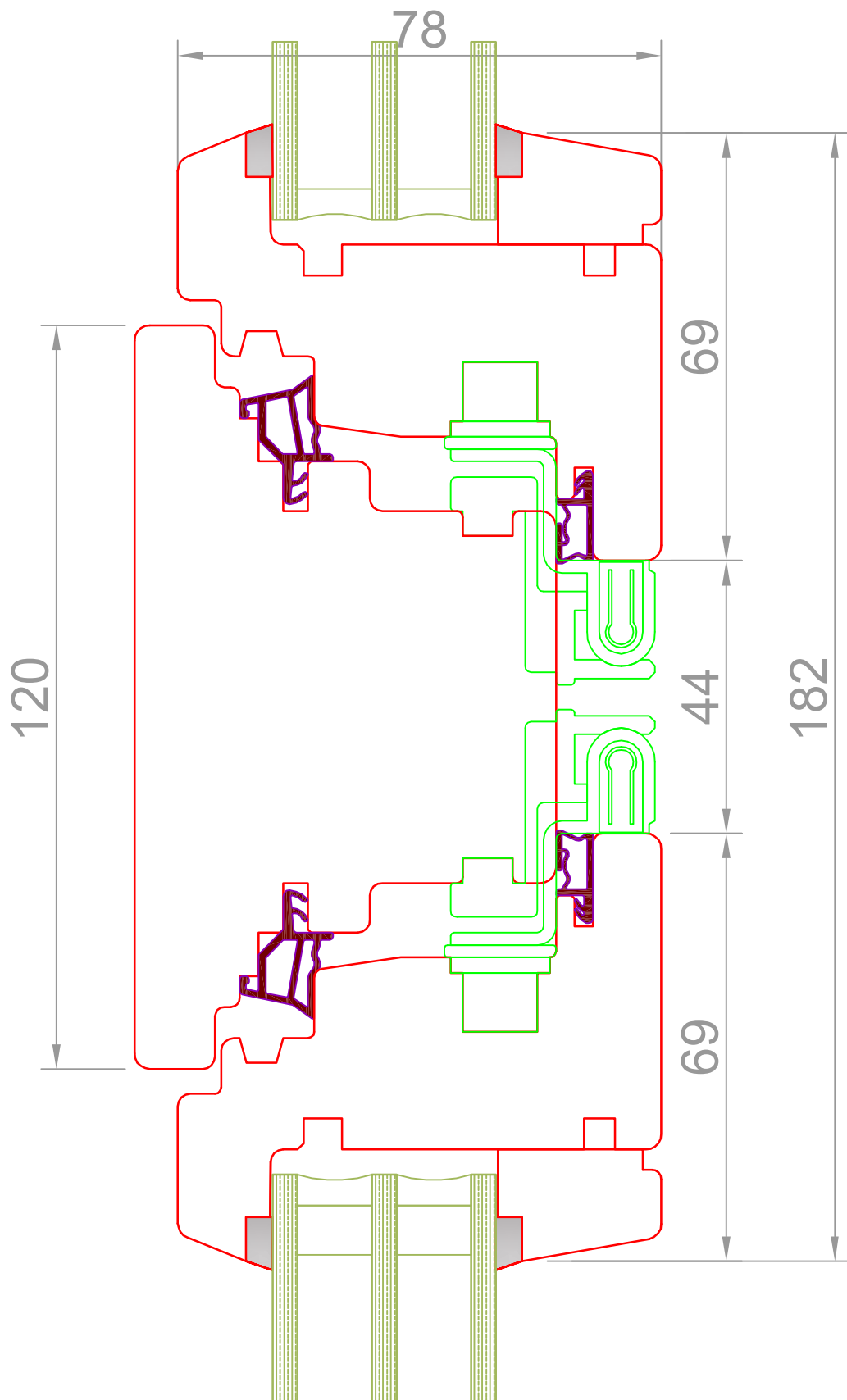

Standardschnitt Glasstärke bzw. Wangentiefe können abweichen

 fenlife Fenster fürs Leben.	Fenlife PUR 68	FORMAT: A4 Gez: SP
	Detail Setzholz 120	Mst: 1:1 Z.Nr.:
Fritschi Fensterbau AG Grundstrasse 39 8196 Wil/ZH		Tel. 043 433 33 66 Fax 043 433 33 67 info@fritschi-fensterbau.ch www.fritschi-fensterbau.ch
		Gez: 01.01.2014 Rev: Druck: 19.08.2017

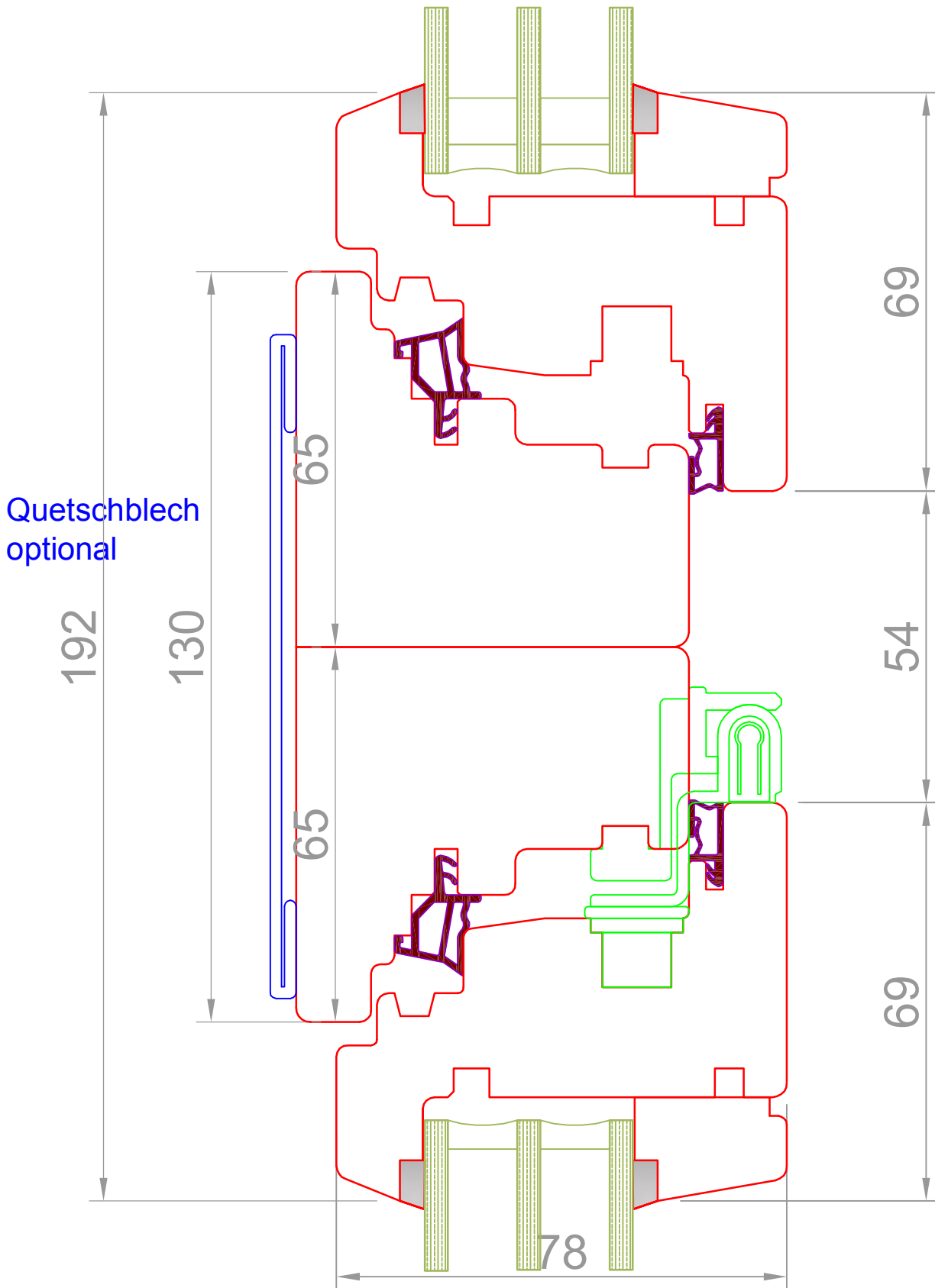

Quetschblech
optional

Standardschnitt Glasstärke bezw. Wangentiefe können abweichen



Fenlife PUR 68

FORMAT: A4
Gez: SP

Detail Zusammenbau

Mst: 1:1
Z.Nr.:

Fritschi Fensterbau AG
Grundstrasse 39
8196 Wil/ZH



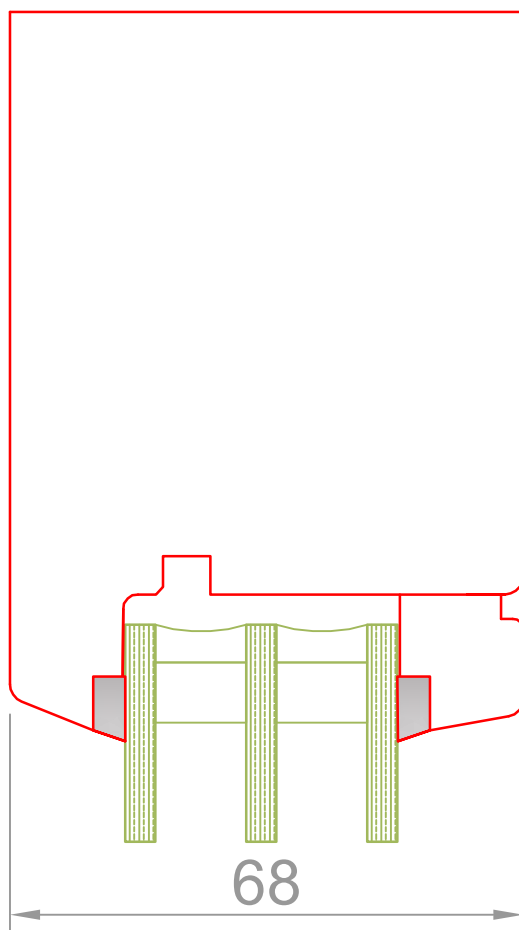

Tel. 043 433 33 66
Fax 043 433 33 67
info@fritschi-fensterbau.ch
www.fritschi-fensterbau.ch

Gez: 01.01.2014
Rev:
Druck: 19.08.2017



Standardschnitt Glasstärke bzw. Wangentiefe können abweichen

 fenlife Fenster fürs Leben.	Fenlife PUR 68	FORMAT: A4 Gez: SP
	Detail i.R. oben seitlich	Mst: 1:1 Z.Nr.:
Fritschi Fensterbau AG Grundstrasse 39 8196 Wil/ZH		Tel. 043 433 33 66 Fax 043 433 33 67 info@fritschi-fensterbau.ch www.fritschi-fensterbau.ch
		Gez: 01.01.2014 Rev: Druck: 19.08.2017

Quetschblech
optional

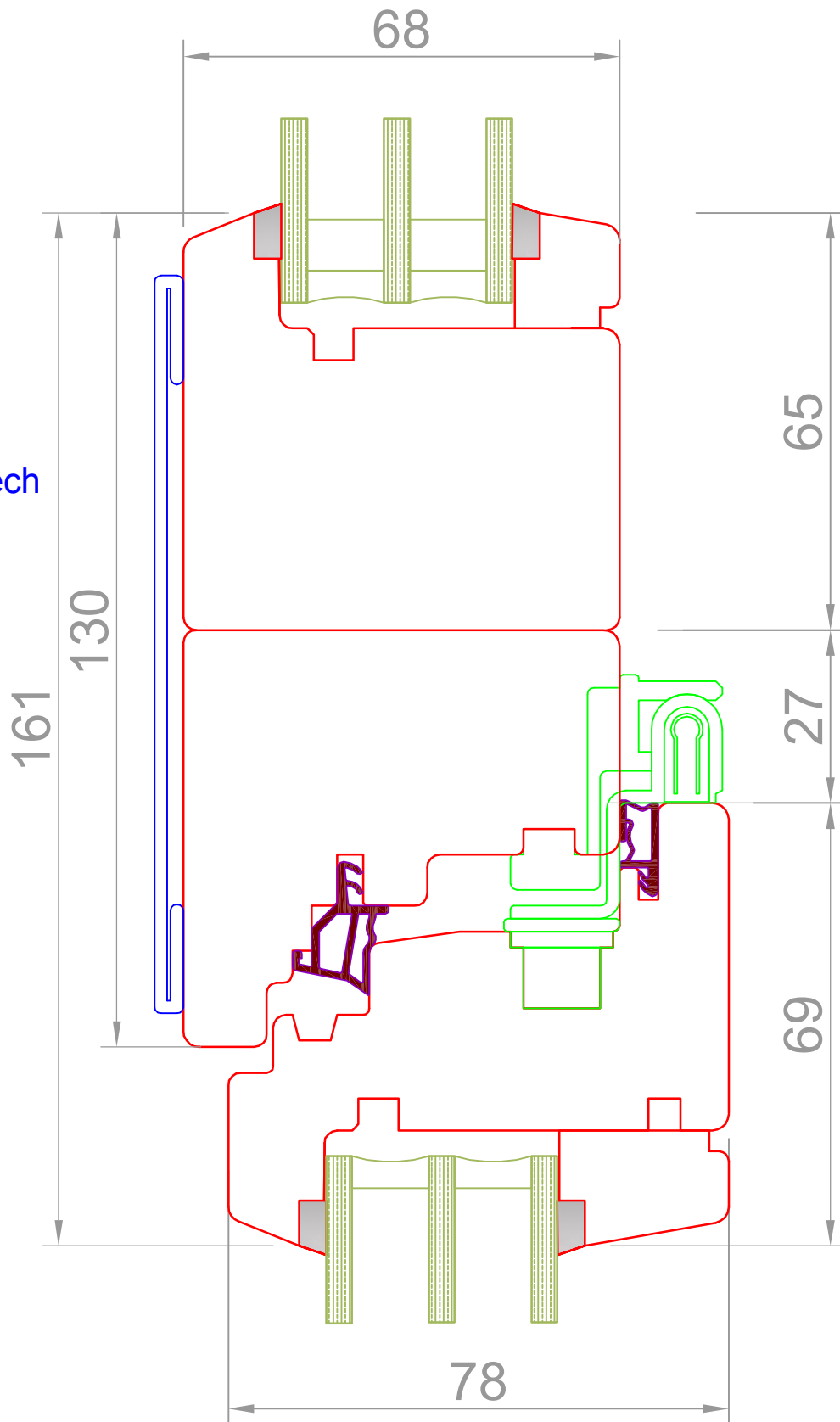

Standardschnitt Glasstärke bzw. Wangentiefe können abweichen

 Fenster fürs Leben.	Fenlife PUR 68	FORMAT: A4 Gez: SP
	Detail Zusammenbau mit i.R.	Mst: 1:1 Z.Nr.:
Fritschi Fensterbau AG Grundstrasse 39 8196 Wil/ZH	 FRITSCHI	Tel. 043 433 33 66 Fax 043 433 33 67 info@fritschi-fensterbau.ch www.fritschi-fensterbau.ch
		Gez: 01.01.2014 Rev: Druck: 19.08.2017

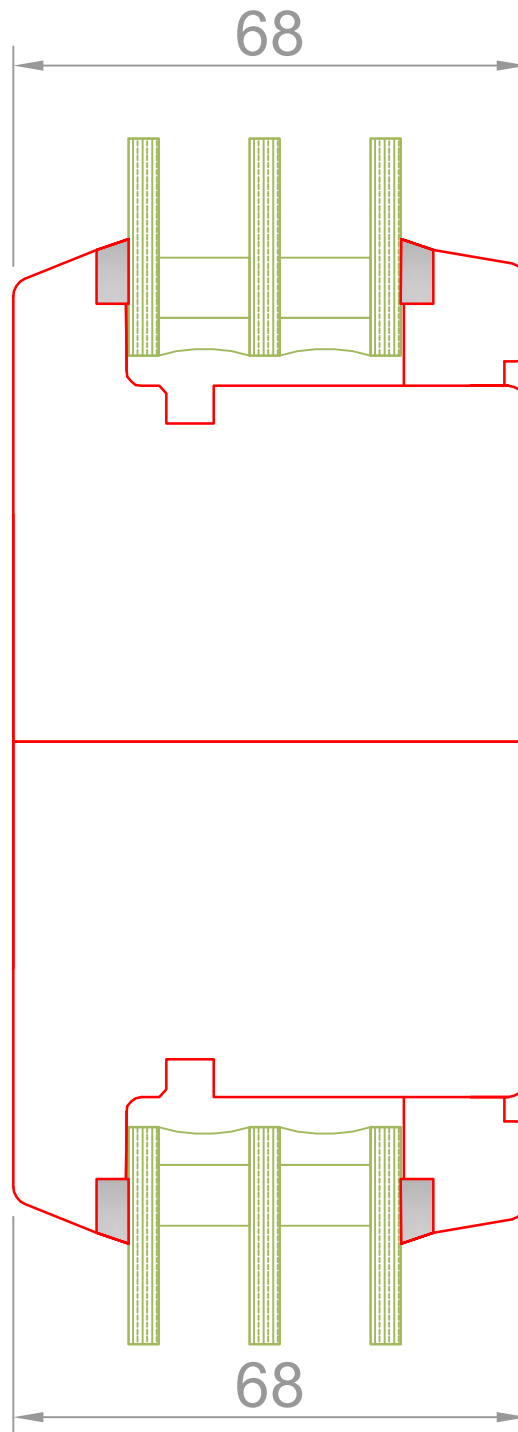

Standardschnitt Glasstärke bezw. Wangentiefe können abweichen

 fenlife Fenster fürs Leben.	Fenlife PUR 68	FORMAT: A4 Gez: SP
	Detail i.R. Zusammenbau	Mst: 1:1 Z.Nr.:
Fritschi Fensterbau AG Grundstrasse 39 8196 Wil/ZH		Tel. 043 433 33 66 Fax 043 433 33 67 info@fritschi-fensterbau.ch www.fritschi-fensterbau.ch
		Gez: 01.01.2014 Rev: Druck: 19.08.2017

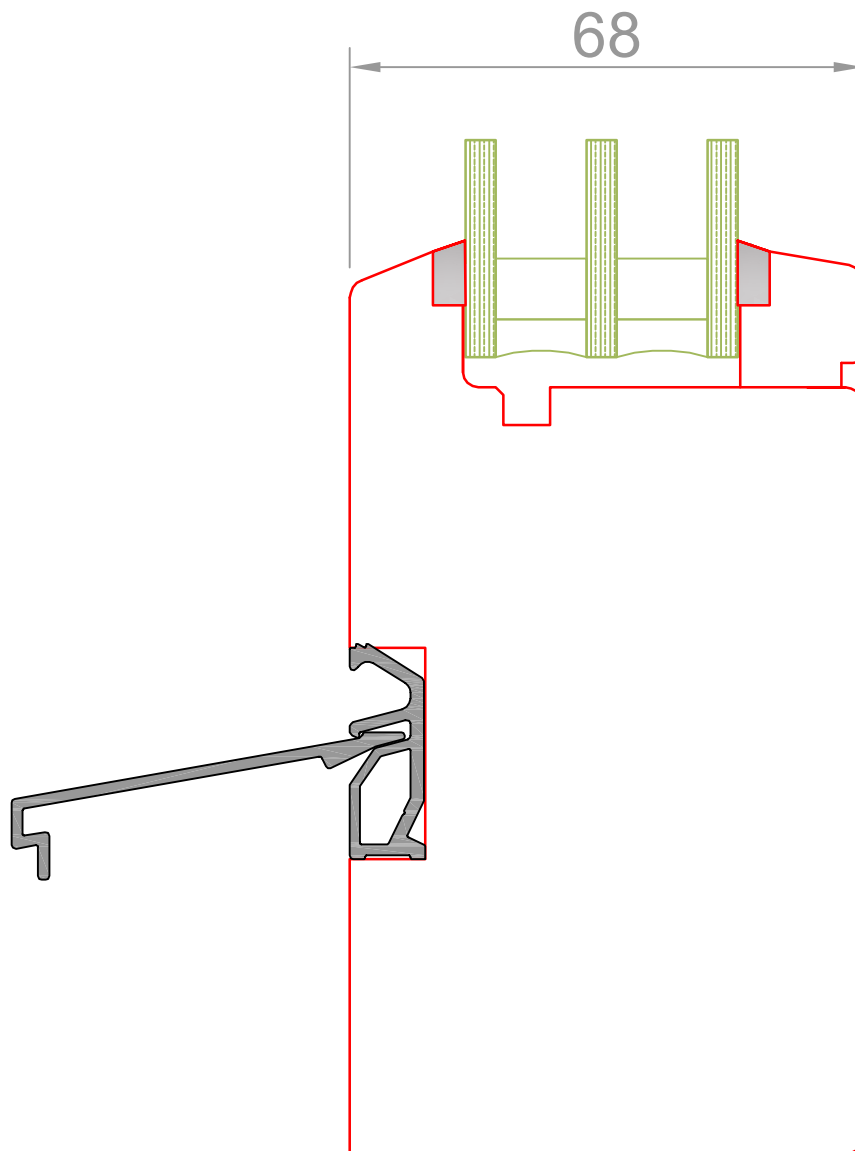

Standardschnitt Glasstärke bzw. Wangentiefe können abweichen

 <p>fenlife Fenster fürs Leben.</p>	Fenlife PUR 68	FORMAT: A4 Gez: SP
	Detail i.R. unten	Mst: 1:1 Z.Nr.:
<p>Fritschi Fensterbau AG Grundstrasse 39 8196 Wil/ZH</p>		<p>Tel. 043 433 33 66 Fax 043 433 33 67 info@fritschi-fensterbau.ch www.fritschi-fensterbau.ch</p>
		<p>Gez: 01.01.2014 Rev: Druck: 19.08.2017</p>

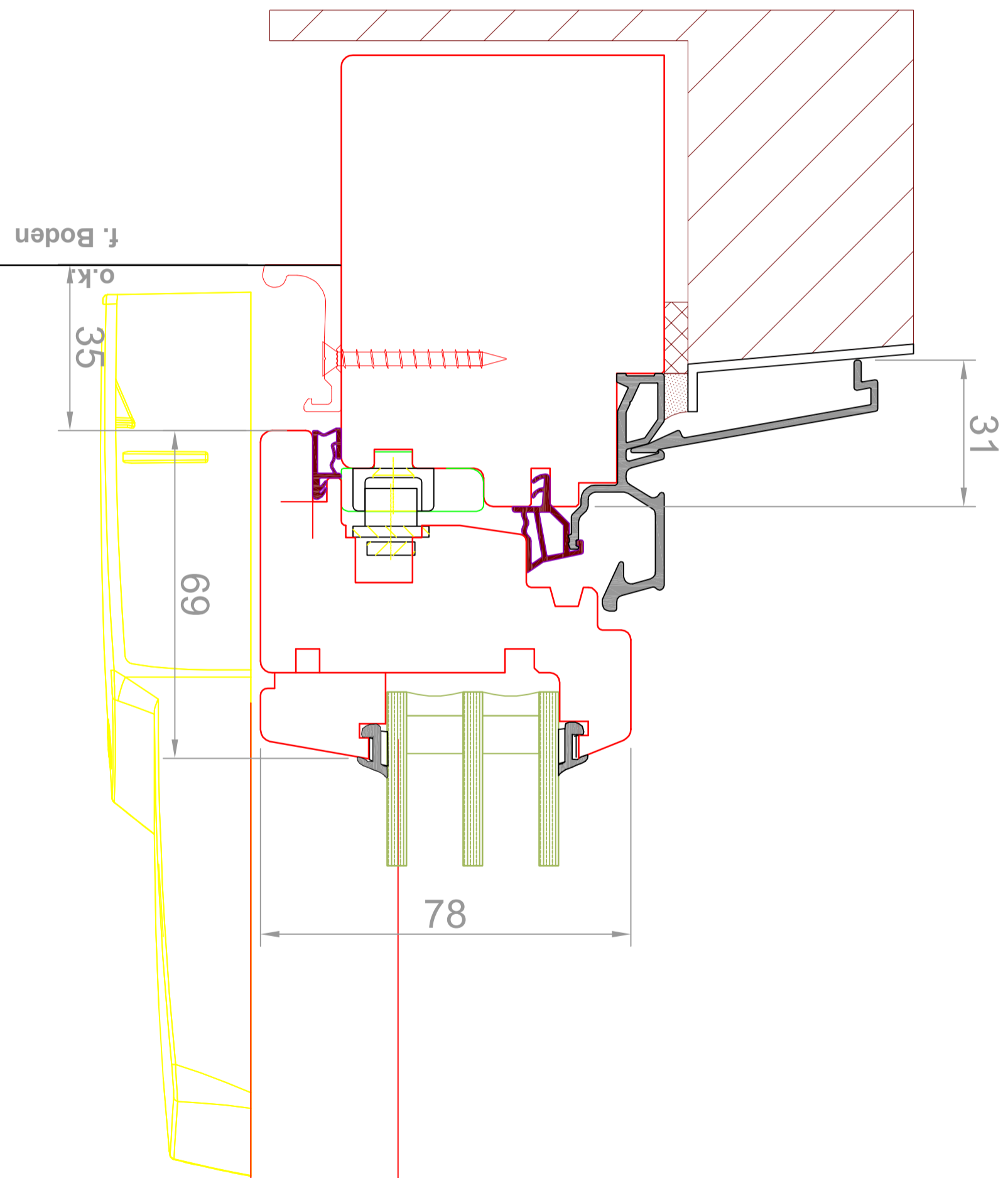

Standardschnitt Glasstärke bzw. Mangentiefe können abweichen



Fenilife PUR 68

FORMAT: A3
Gez.: SP

Detail unten PAS / PSK

Mst: 1:1
Z.Nr.:

Fritschi Fensterbau AG
Grundstrasse 39
8196 Wil/ZH



Tel. 043 433 33 66
Fax 043 433 33 67
info@fritschi-fensterbau.ch
www.fritschi-fensterbau.ch

Gez.: 01.01.2014
Rev:
Druck: 19.08.2017

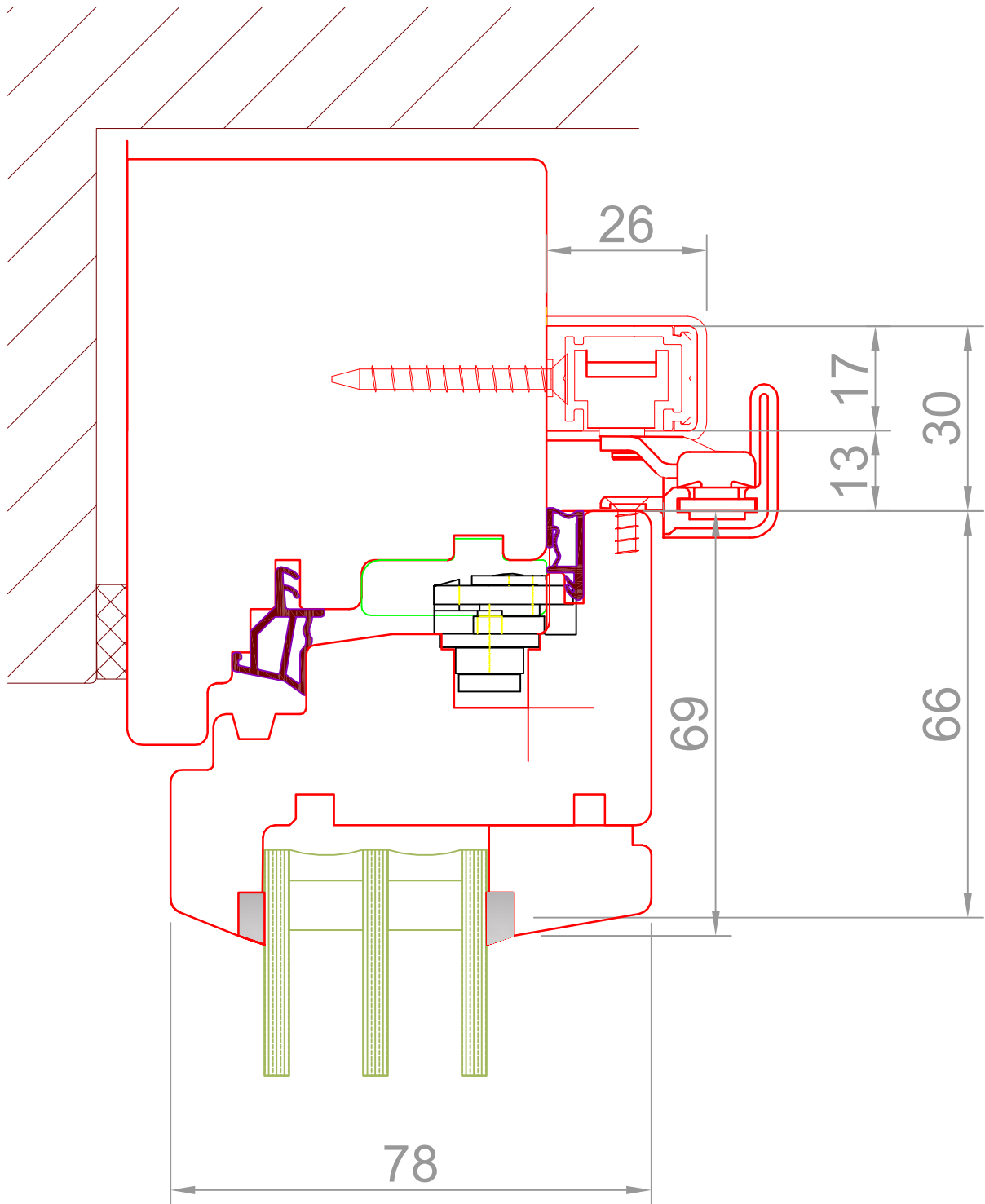

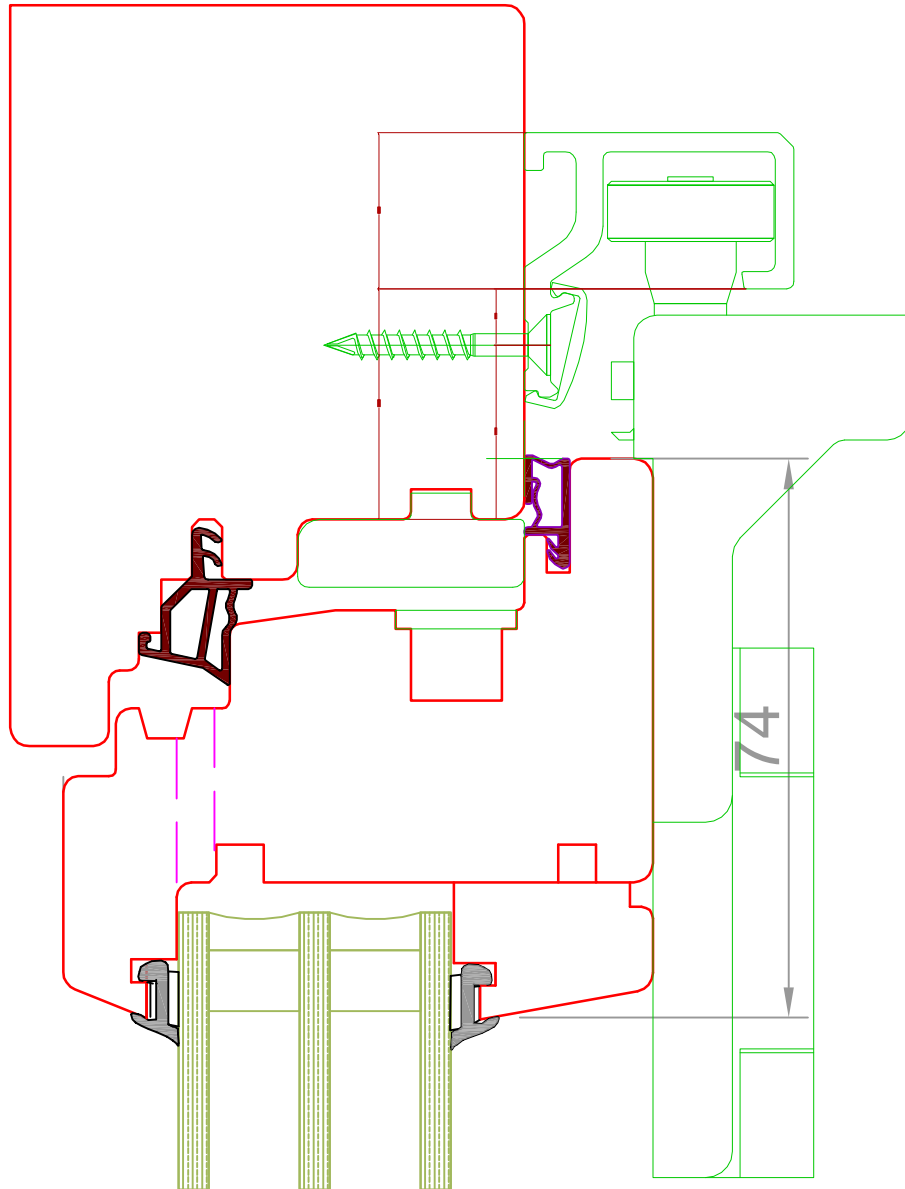

Standardschnitt Glasstärke bzw. Wangentiefe können abweichen

 fenlife Fenster fürs Leben.	Fenlife PUR 68	FORMAT: A4 Gez: SP
	Detail oben PAS / PSK	Mst: 1:1 Z.Nr.:
Fritschi Fensterbau AG Grundstrasse 39 8196 Wil/ZH		Tel. 043 433 33 66 Fax 043 433 33 67 info@fritschi-fensterbau.ch www.fritschi-fensterbau.ch
		Gez: 01.01.2014 Rev: Druck:19.08.2017



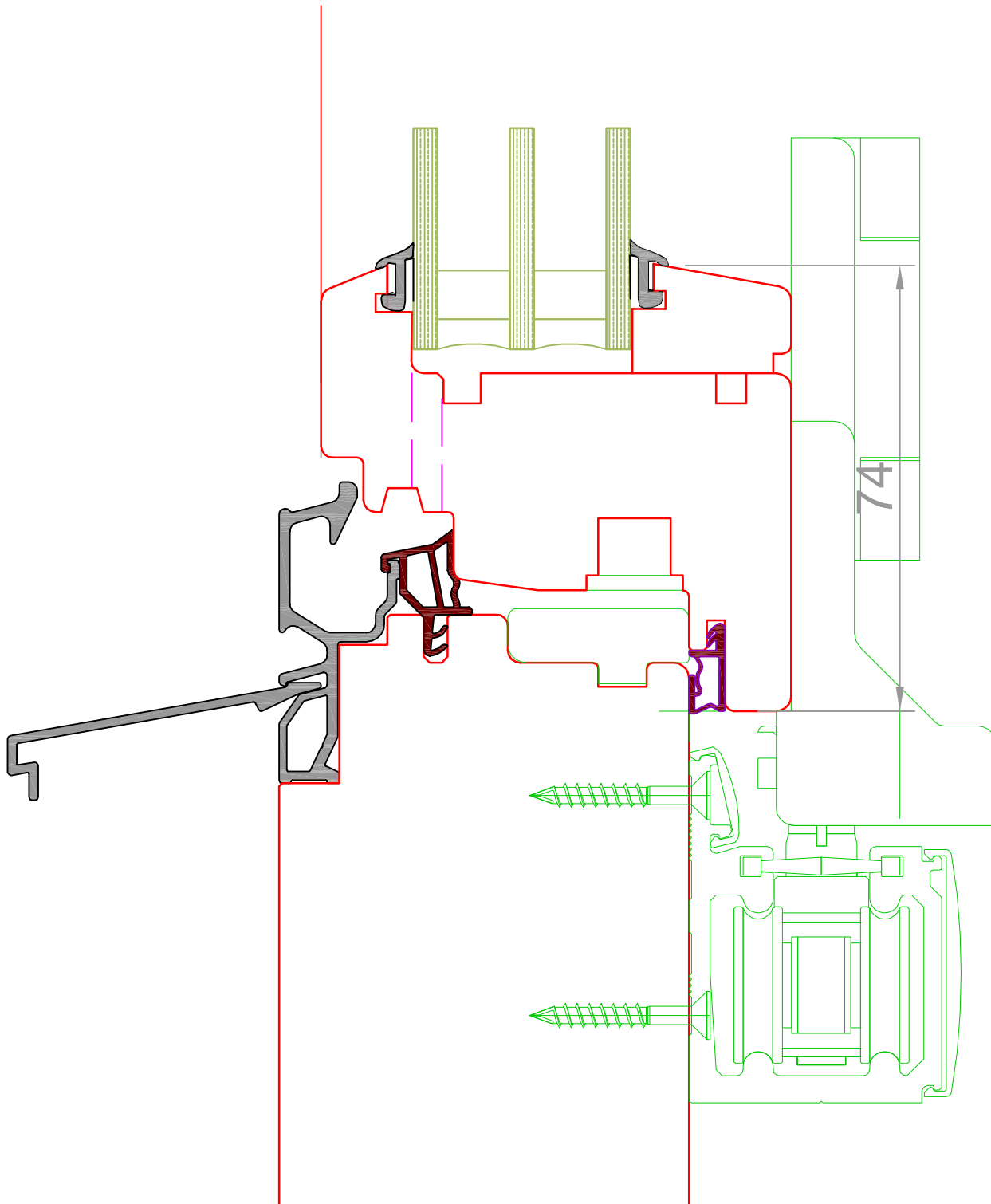

Standardschnitt Glasstärke bzw. Wangentiefe können abweichen

 fenlife Fenster fürs Leben.	Fenlife PUR 68	FORMAT: A4 Gez: SP
	Detail oben FS-Portal	Mst: 1:1 Z.Nr.:
Fritschi Fensterbau AG Grundstrasse 39 8196 Wil/ZH		Tel. 043 433 33 66 Fax 043 433 33 67 info@fritschi-fensterbau.ch www.fritschi-fensterbau.ch
		Gez: 01.01.2014 Rev: Druck: 19.08.2017



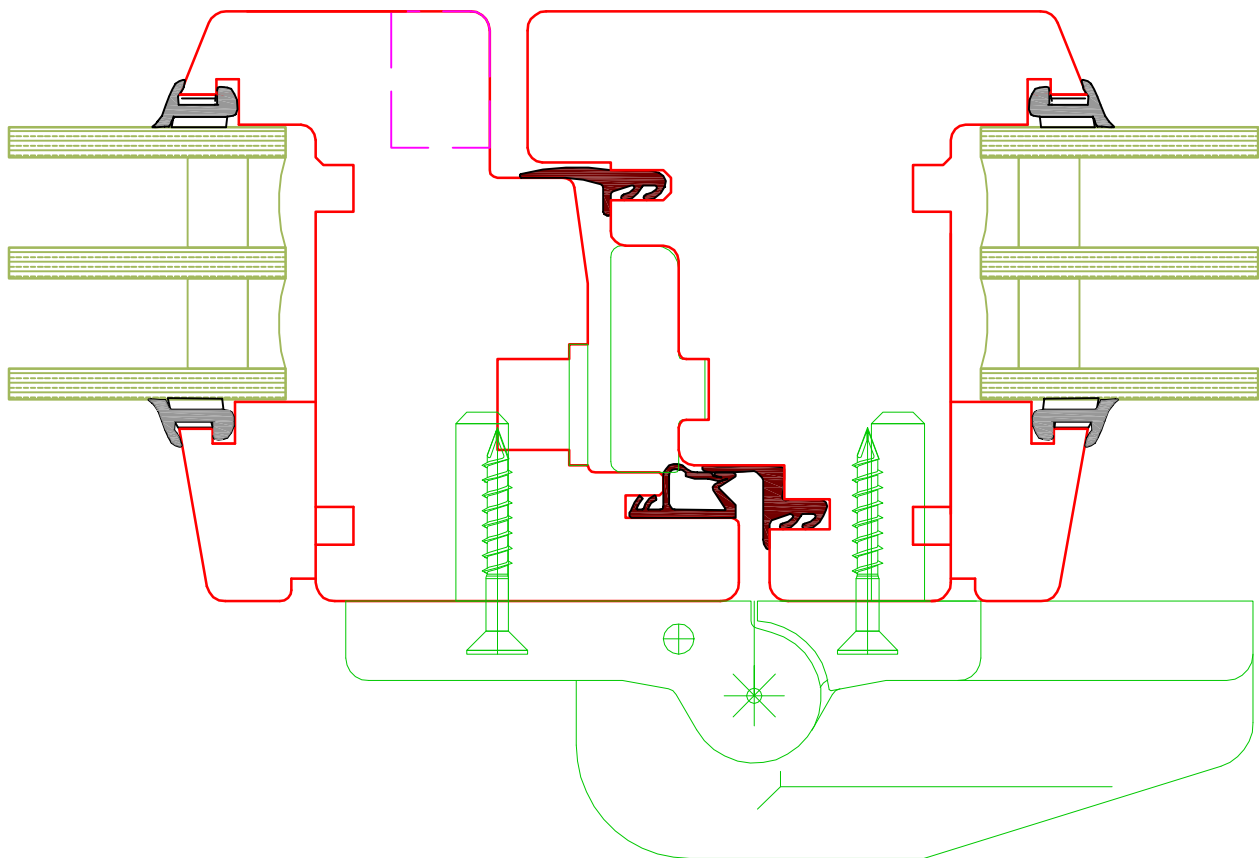

Standardschnitt Glasstärke bzw. Wangentiefe können abweichen

 fenlife Fenster fürs Leben.	Fenlife PUR 68	FORMAT: A4 Gez: SP
	Detail unten FS-Portal	Mst: 1:1 Z.Nr.:
Fritschi Fensterbau AG Grundstrasse 39 8196 Wil/ZH		Tel. 043 433 33 66 Fax 043 433 33 67 info@fritschi-fensterbau.ch www.fritschi-fensterbau.ch
		Gez: 01.01.2014 Rev: Druck:19.08.2017



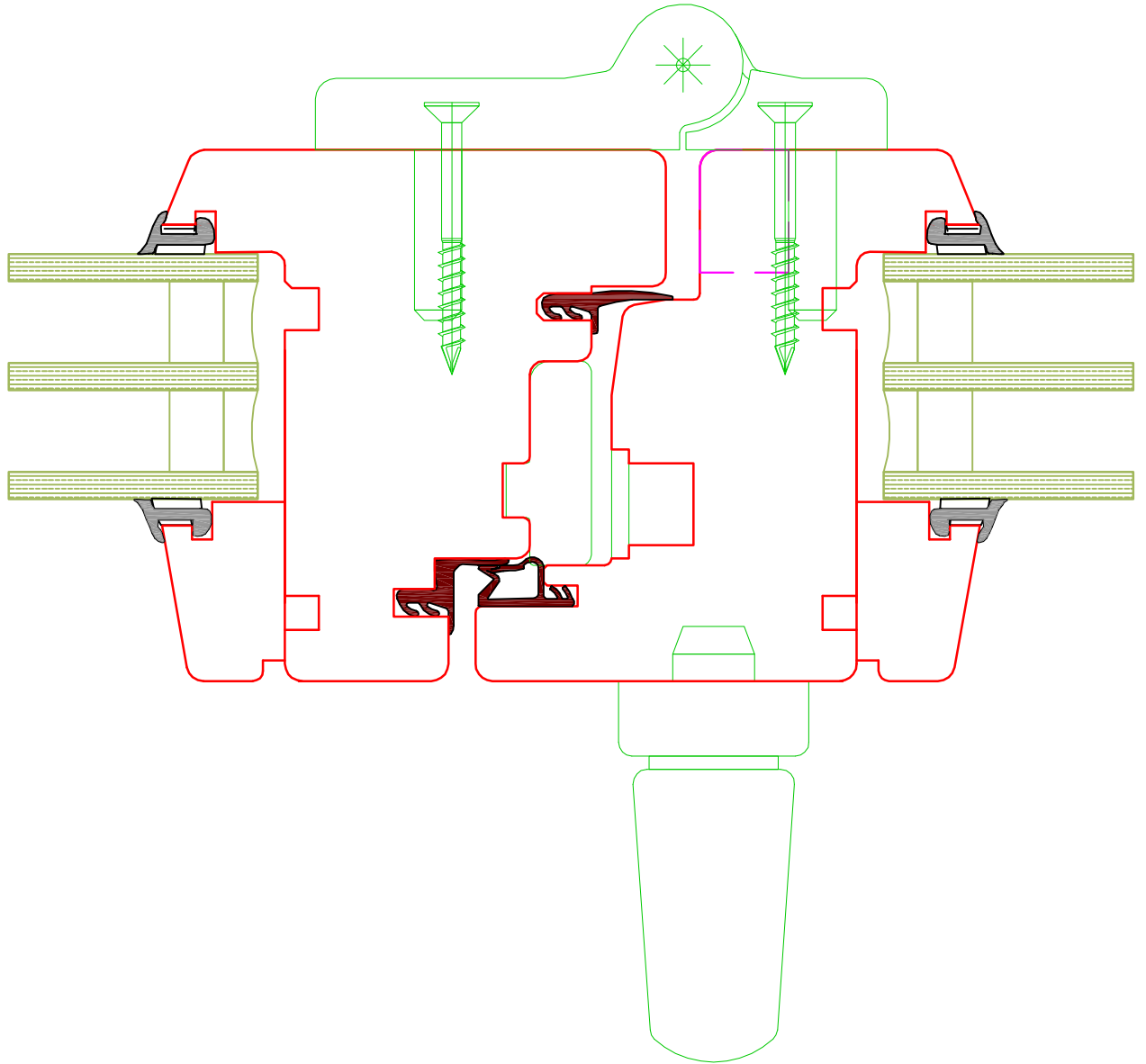

Standardschnitt Glasstärke bzw. Wangentiefe können abweichen

 fenlife Fenster fürs Leben.	Fenlife PUR 68	FORMAT: A4 Gez: SP
	Detail FS-Portal Band innen	Mst: 1:1 Z.Nr.:
Fritschi Fensterbau AG Grundstrasse 39 8196 Wil/ZH		Tel. 043 433 33 66 Fax 043 433 33 67 info@fritschi-fensterbau.ch www.fritschi-fensterbau.ch
		Gez: 01.01.2014 Rev: Druck: 19.08.2017



Standardschnitt Glasstärke bzw. Wangentiefe können abweichen

 fenlife Fenster fürs Leben.	Fenlife PUR 68	FORMAT: A4 Gez: SP
	Detail FS-Portal Band aussen	Mst: 1:1 Z.Nr.:
Fritschi Fensterbau AG Grundstrasse 39 8196 Wil/ZH		Tel. 043 433 33 66 Fax 043 433 33 67 info@fritschi-fensterbau.ch www.fritschi-fensterbau.ch
		Gez: 01.01.2014 Rev: Druck:19.08.2017

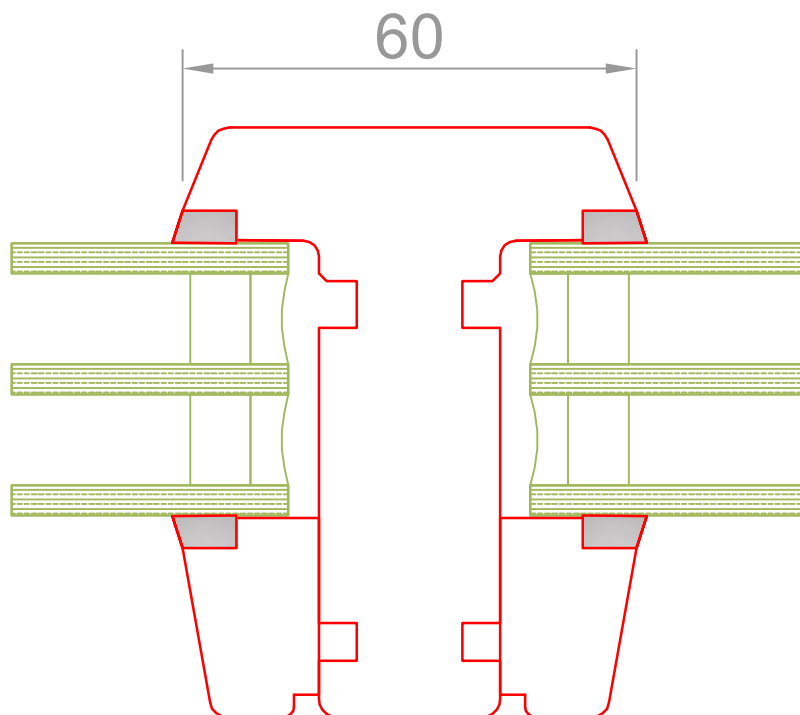

Standardschnitt Glasstärke bzw. Wangentiefe können abweichen

 fenlife Fenster fürs Leben.	Fenlife PUR 68	FORMAT: A4 Gez: SP
	Detail Sprossen Glasteilend	Mst: 1:1 Z.Nr.:
Fritschi Fensterbau AG Grundstrasse 39 8196 Wil/ZH		Tel. 043 433 33 66 Fax 043 433 33 67 info@fritschi-fensterbau.ch www.fritschi-fensterbau.ch
		Gez: 01.01.2014 Rev: Druck:19.08.2017

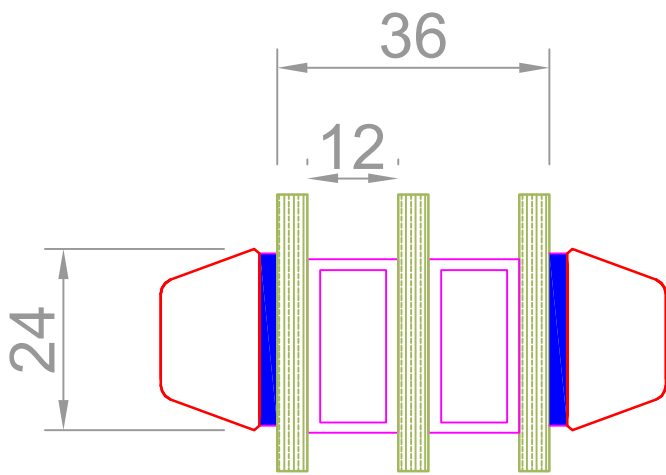

Landhausprosse

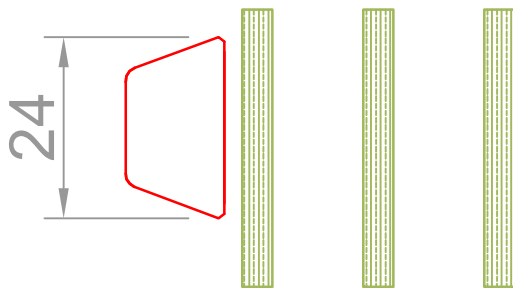

vorgesetzt
mit Metallklips

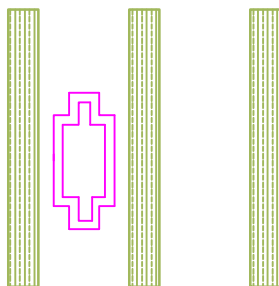

im Isolierglas

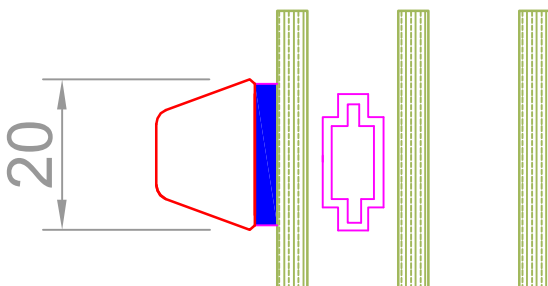

im Glas 18 mm
ausser aufgesiegt 20 mm



Fenlife PUR 68

FORMAT: A4
Gez: SP

Detail Sprossen 3-fach ED 36

Mst: 1:1
Z.Nr.:

Fritschi Fensterbau AG
Grundstrasse 39
8196 Wil/ZH



Tel. 043 433 33 66
Fax 043 433 33 67
info@fritschi-fensterbau.ch
www.fritschi-fensterbau.ch

Gez: 01.01.2014
Rev:
Druck: 19.08.2017